

HY-330

fall semester 2021

Introduction to telecommunication systems theory

University of Crete
Computer Science Department

Stefanos Papadakis

Sampling & Quantization

- ✦ Why?
- ✦ Analog domain - Digital domain
 - ✦ continuous-time vs. discrete-time signals
- ✦ Limits
- ✦ Aliasing...

Analog == Perfect?

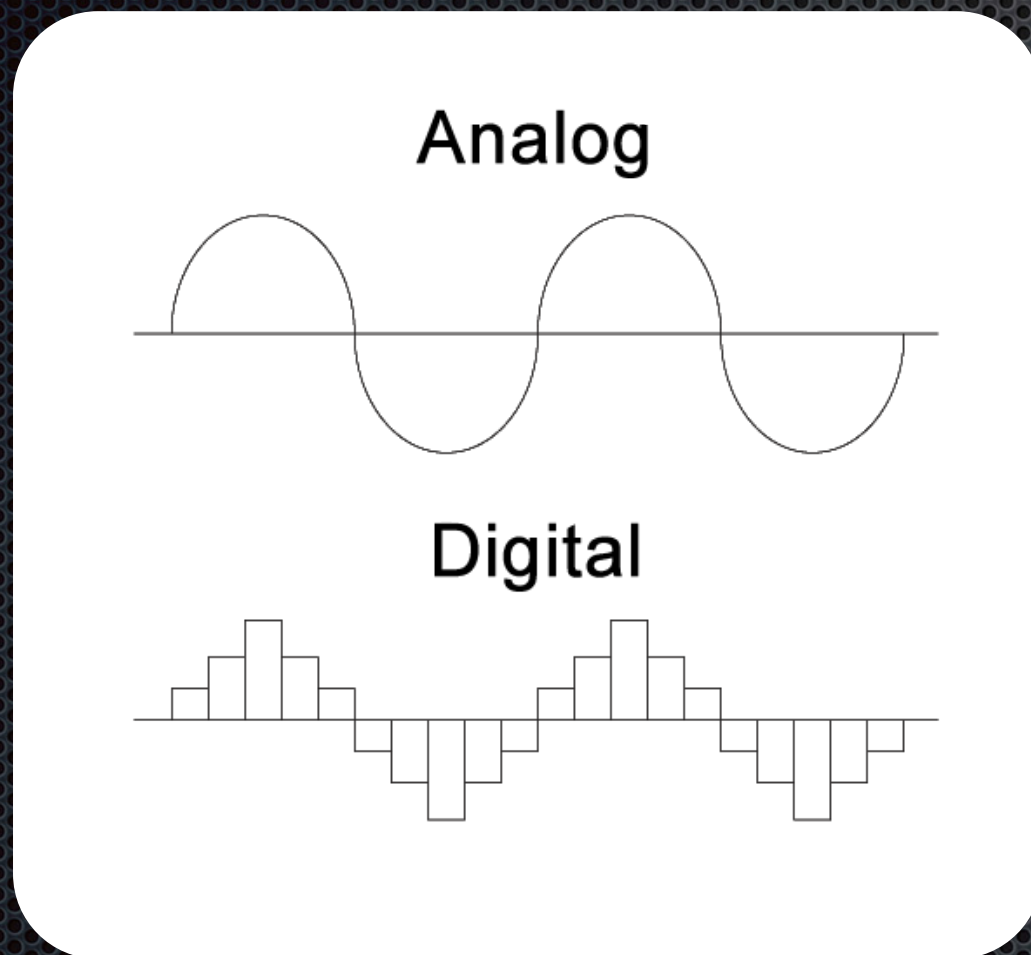

Analog == Perfect?

Analog

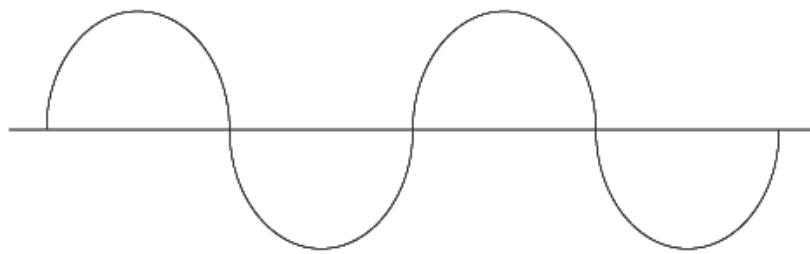

Digital

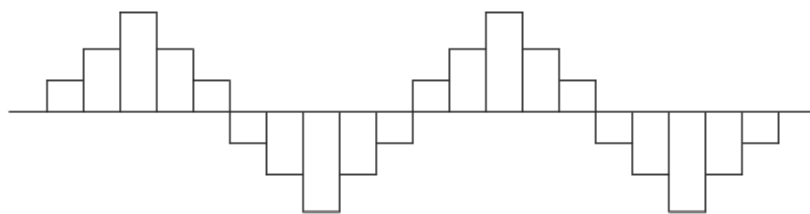

Analog == Perfect?

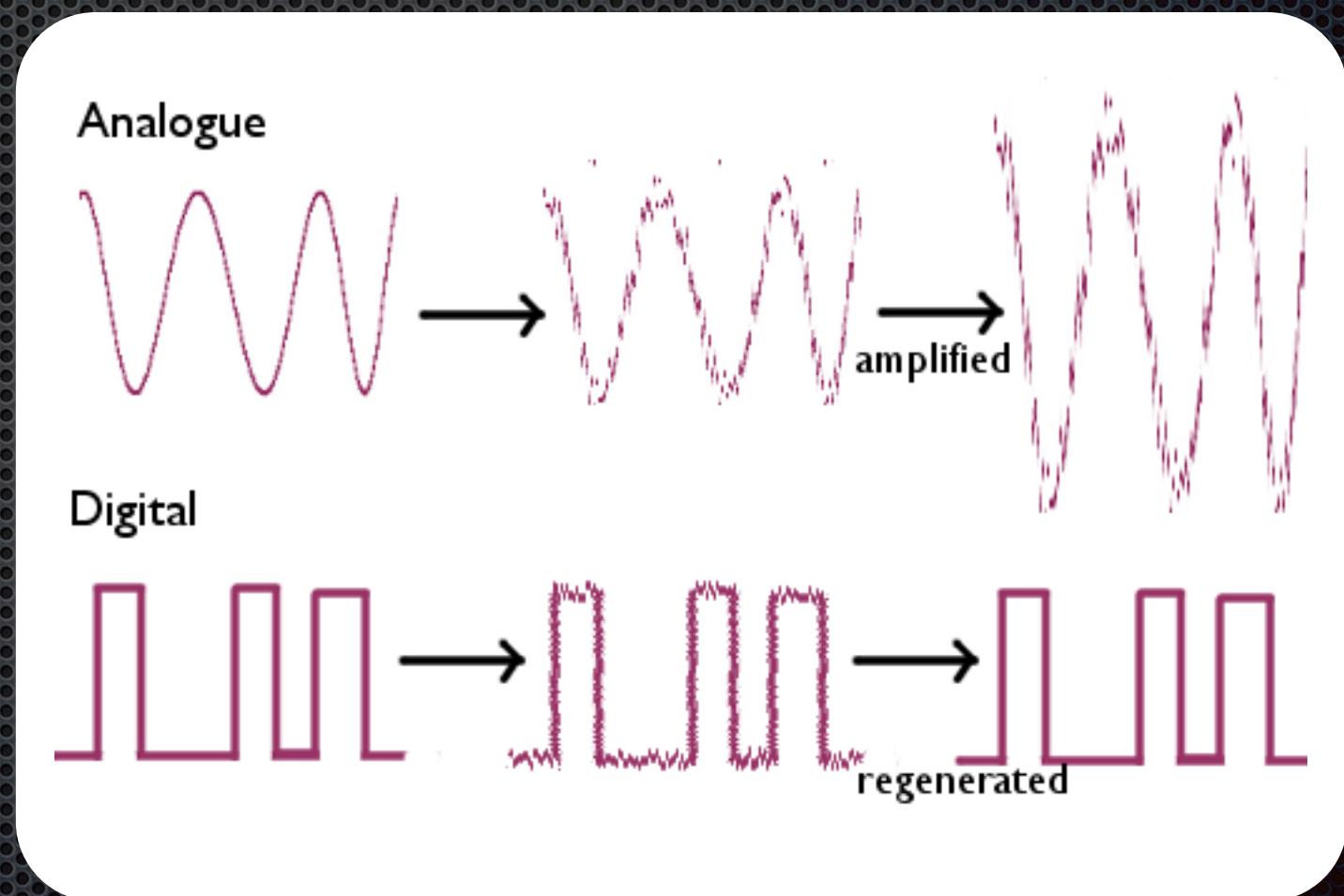
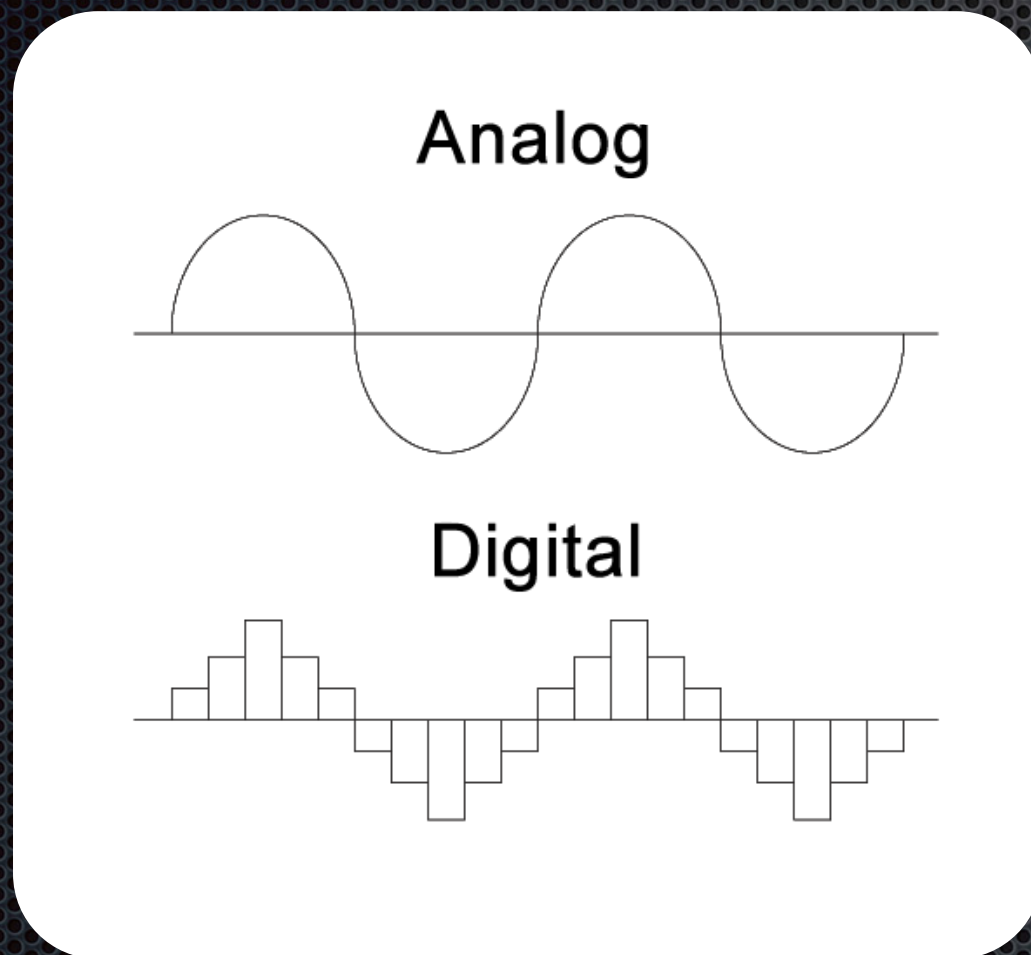

Sampling

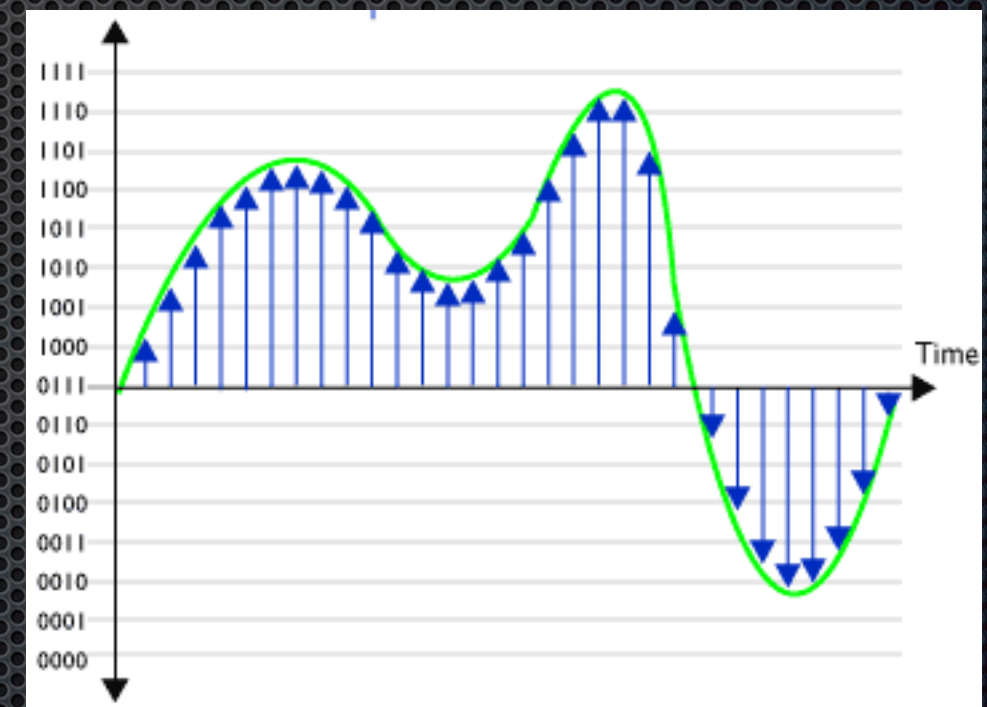
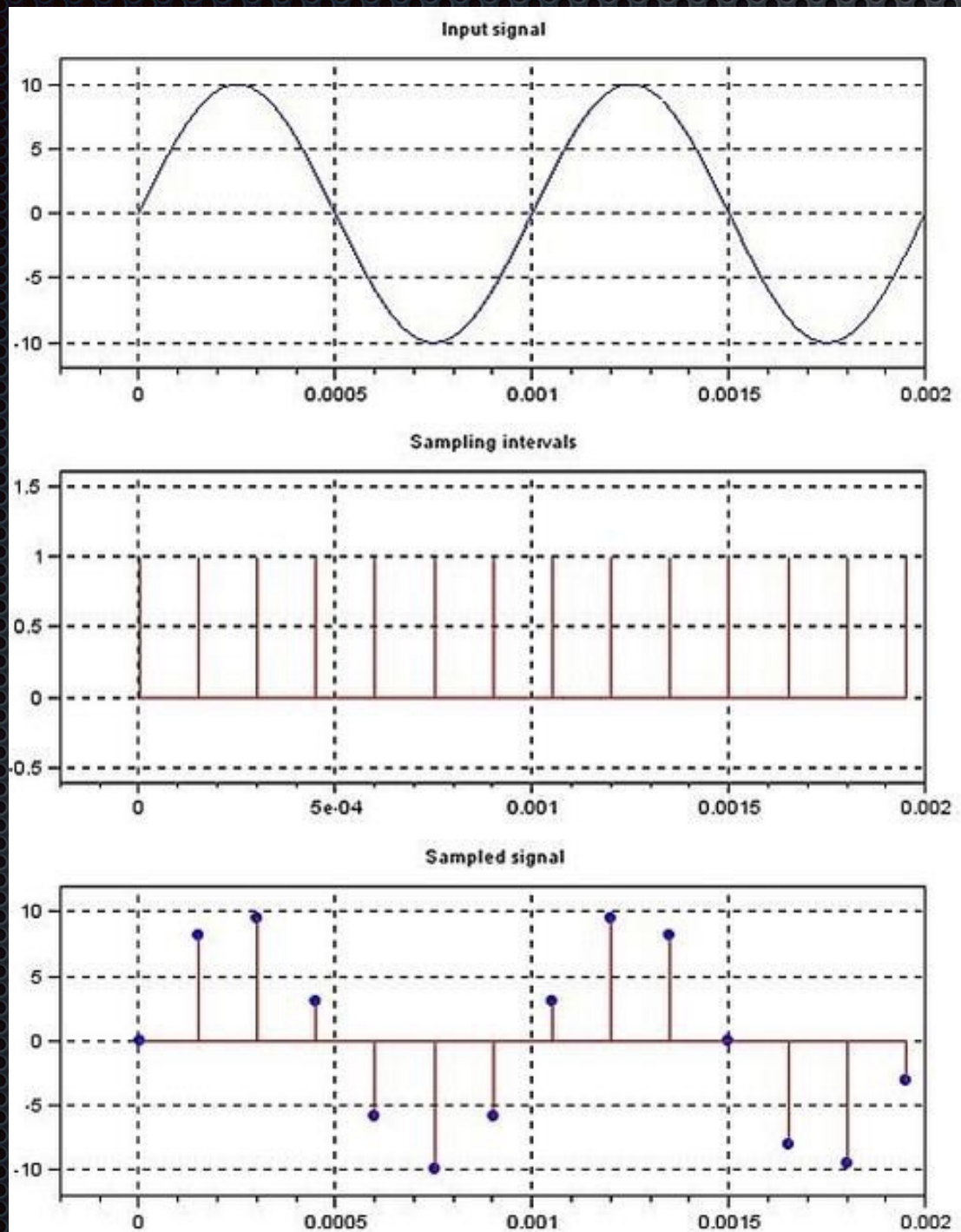

Quantization

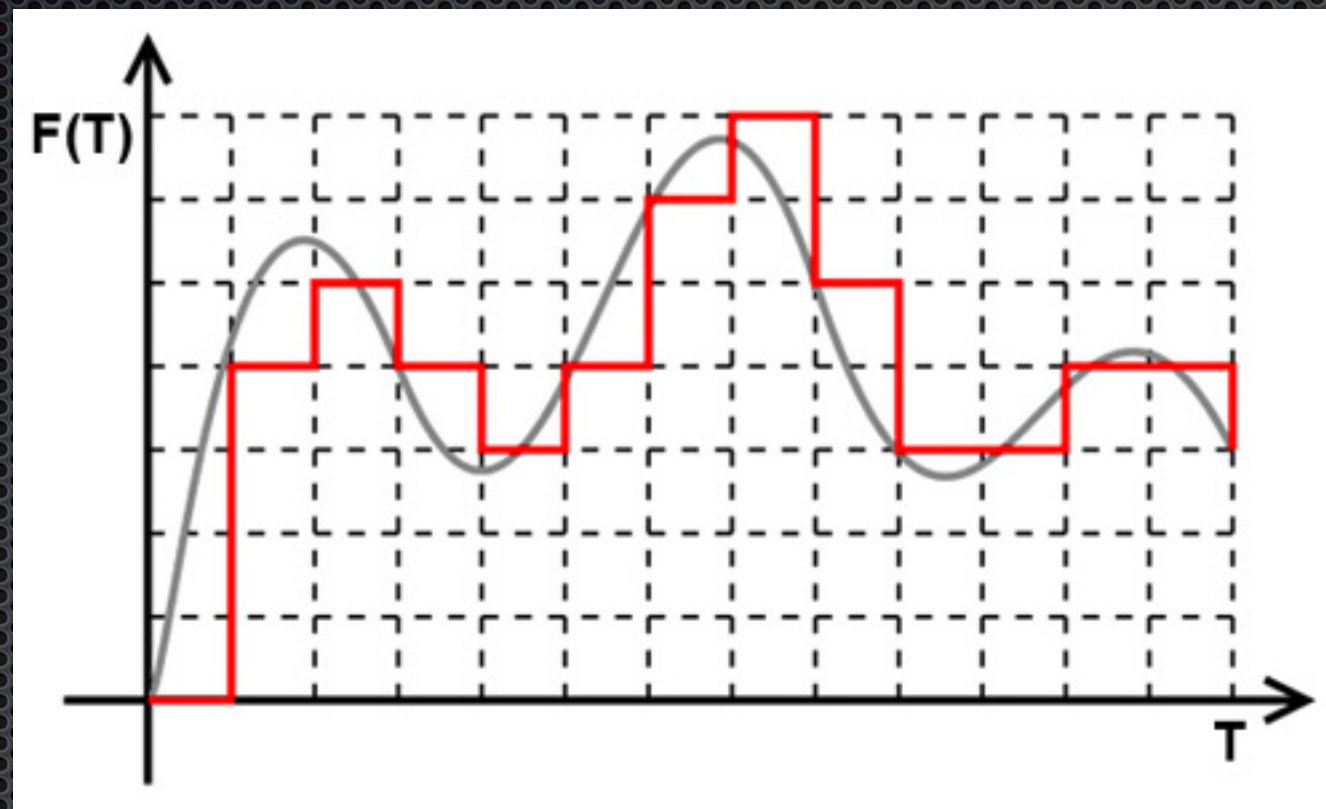

Quantization Error

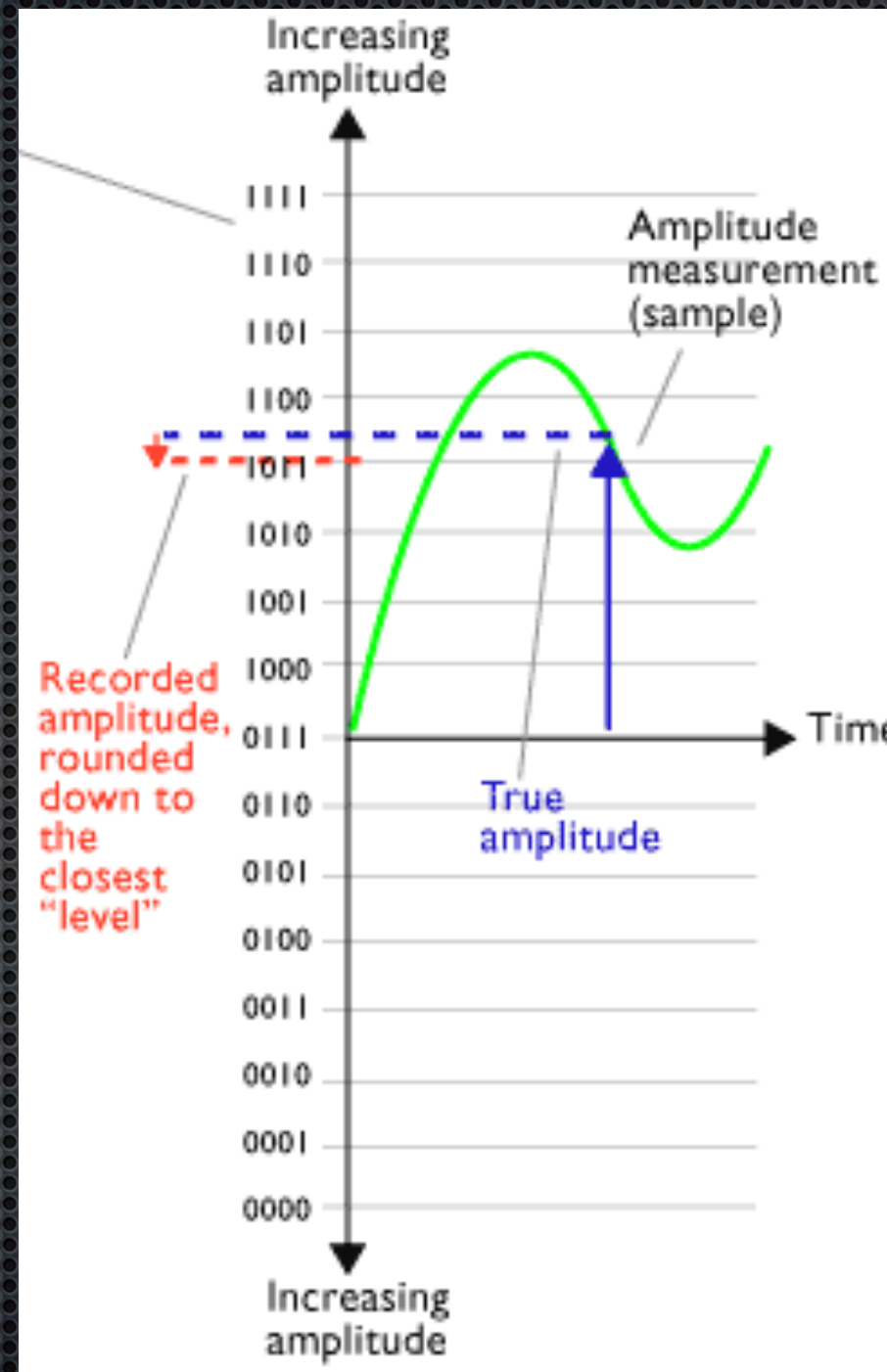

Quantization Noise

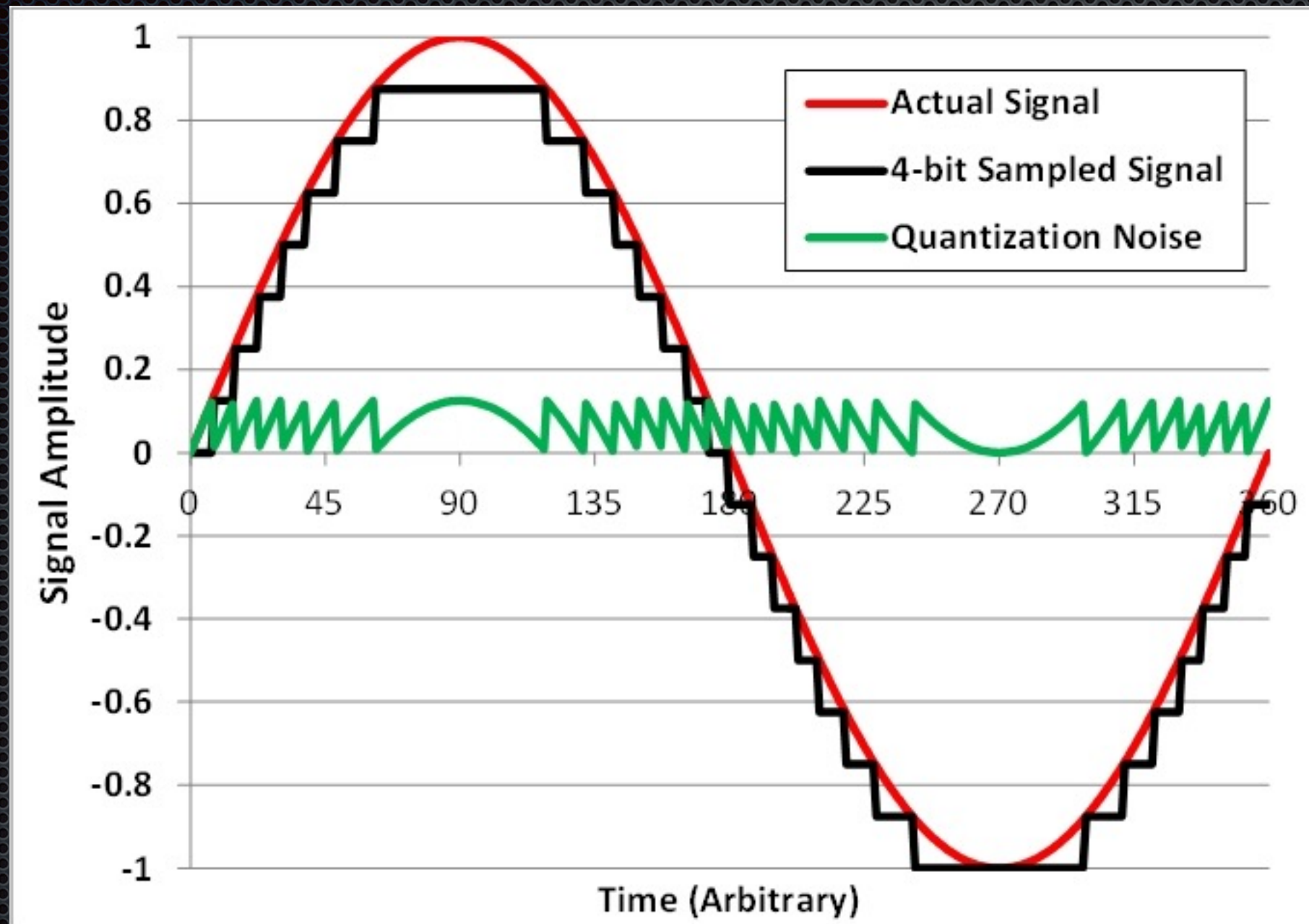

$$SQNR = 20 \log_{10}(2^Q) \approx 6.02 \cdot Q \text{ dB}$$

Nyquist rate

▪ Bandlimited signal of Bandwidth:

$$B$$

▪ Sampling rate (uniform):

$$f_s$$

▪ Nyquist Rate

$$f_s > 2B$$

▪ Nyquist Bandwidth

$$B < f_s/2$$

Nyquist rate

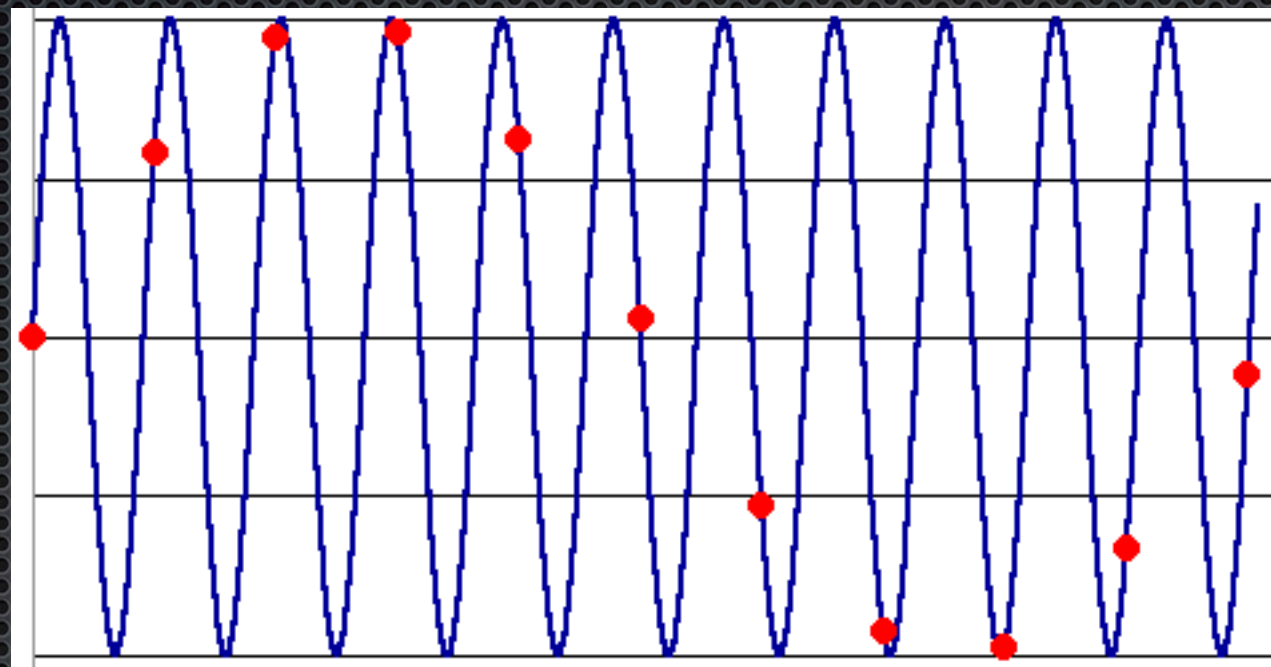

Sampling frequency domain

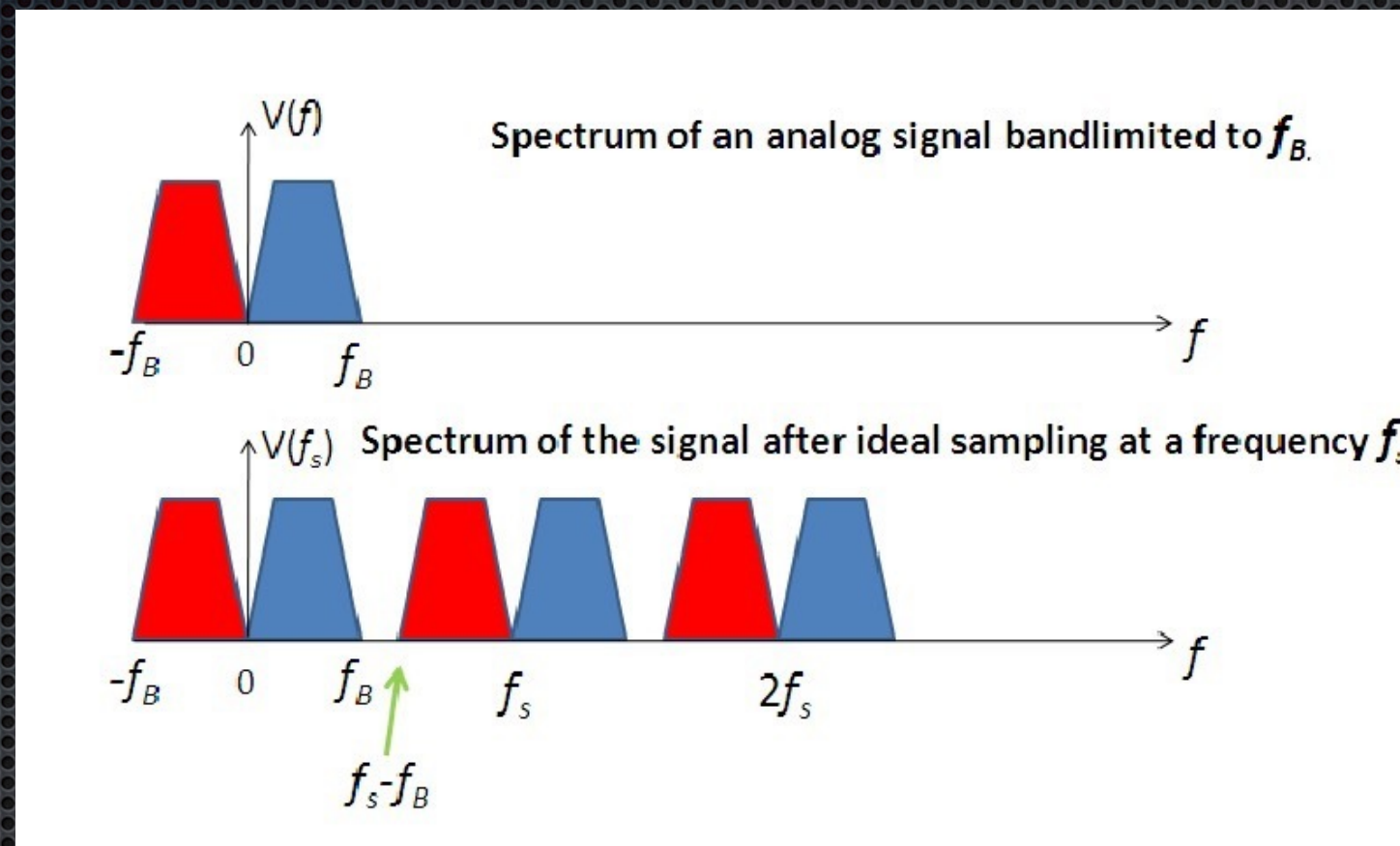

Aliasing

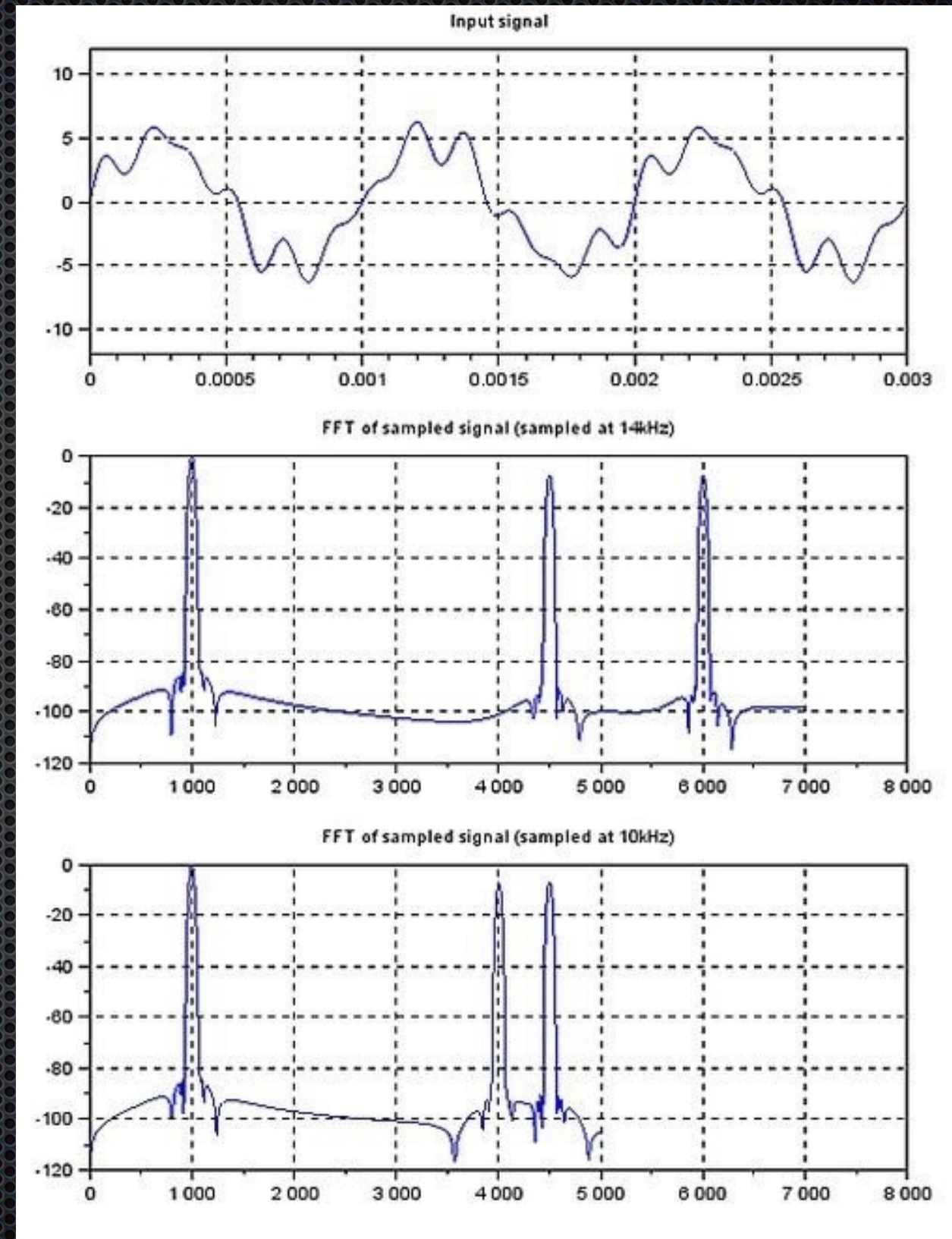
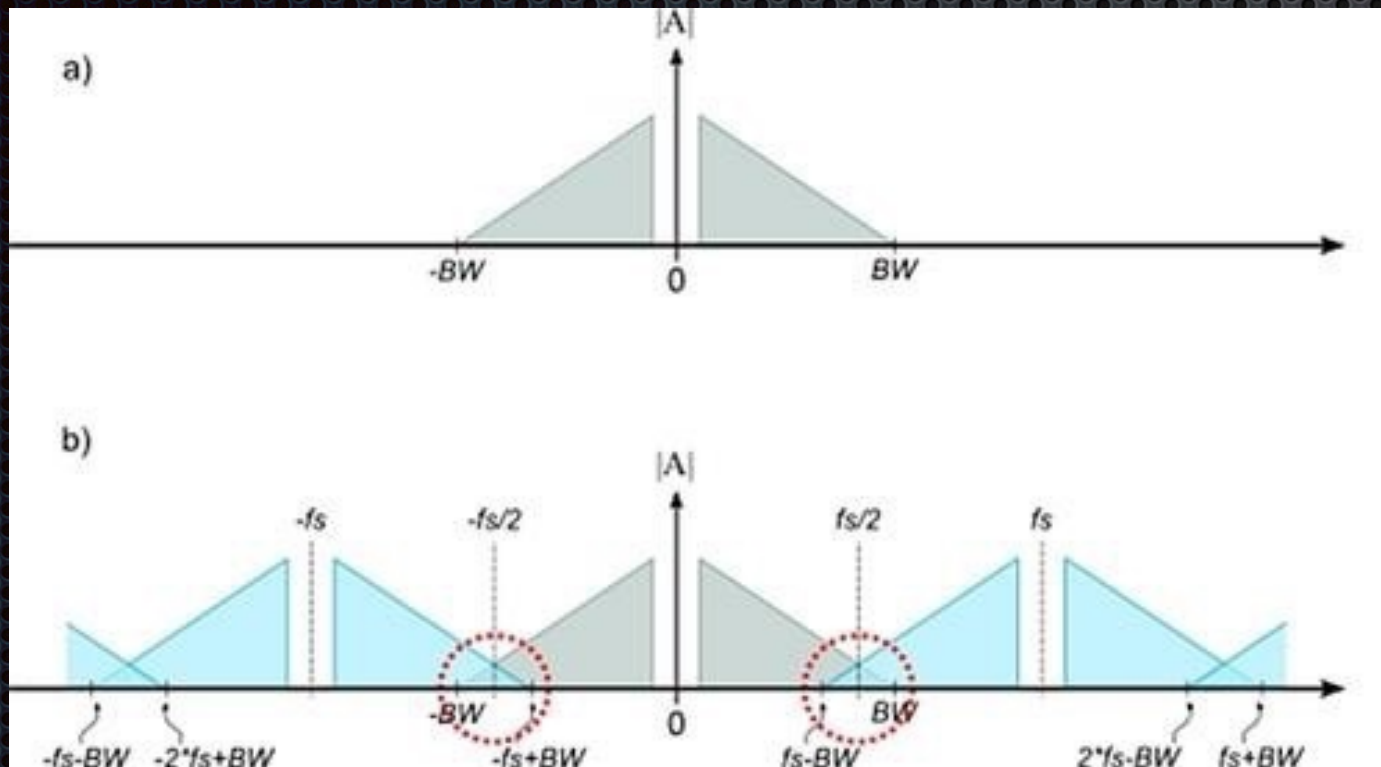

Passband Aliasing

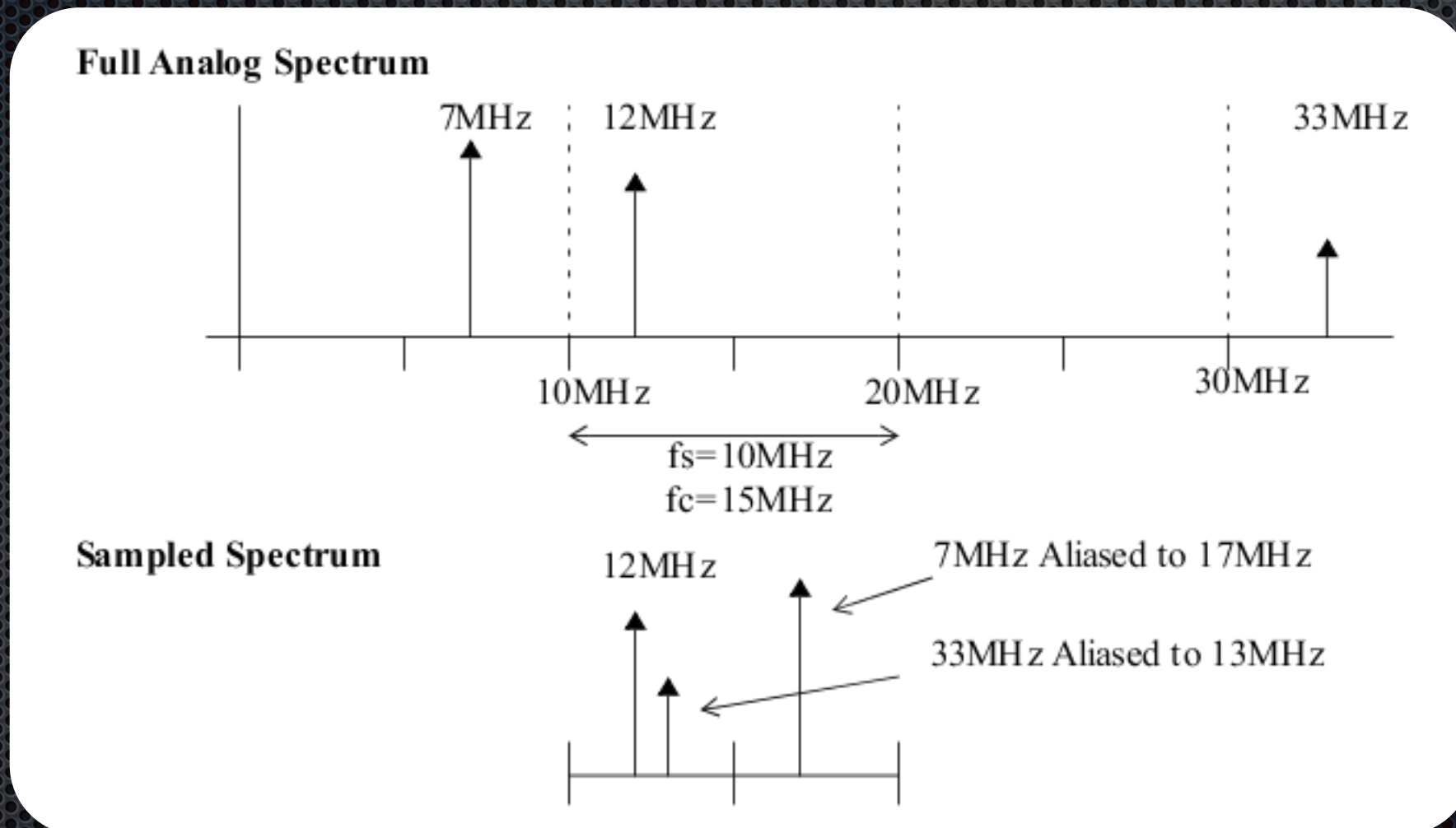

Aliasing in images



Aliasing in images



Aliasing in videos



ADC

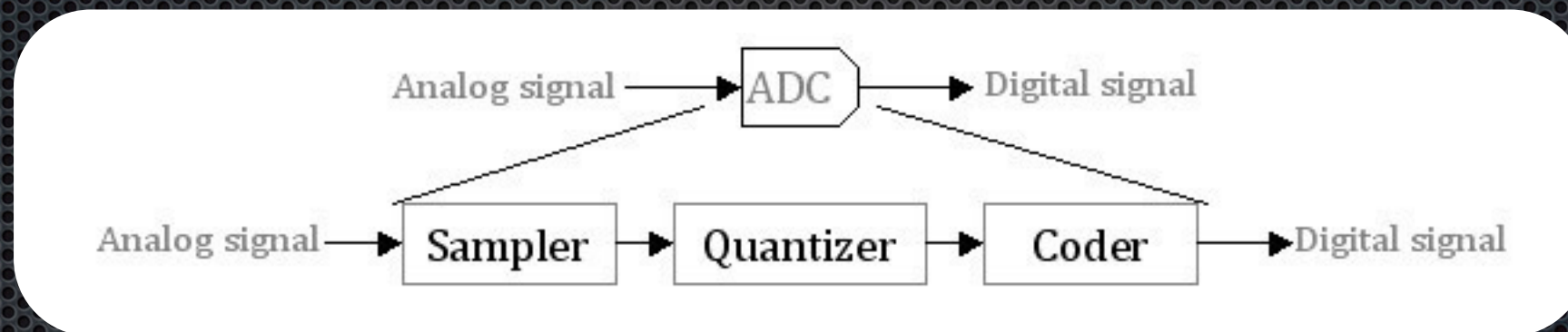

DAC

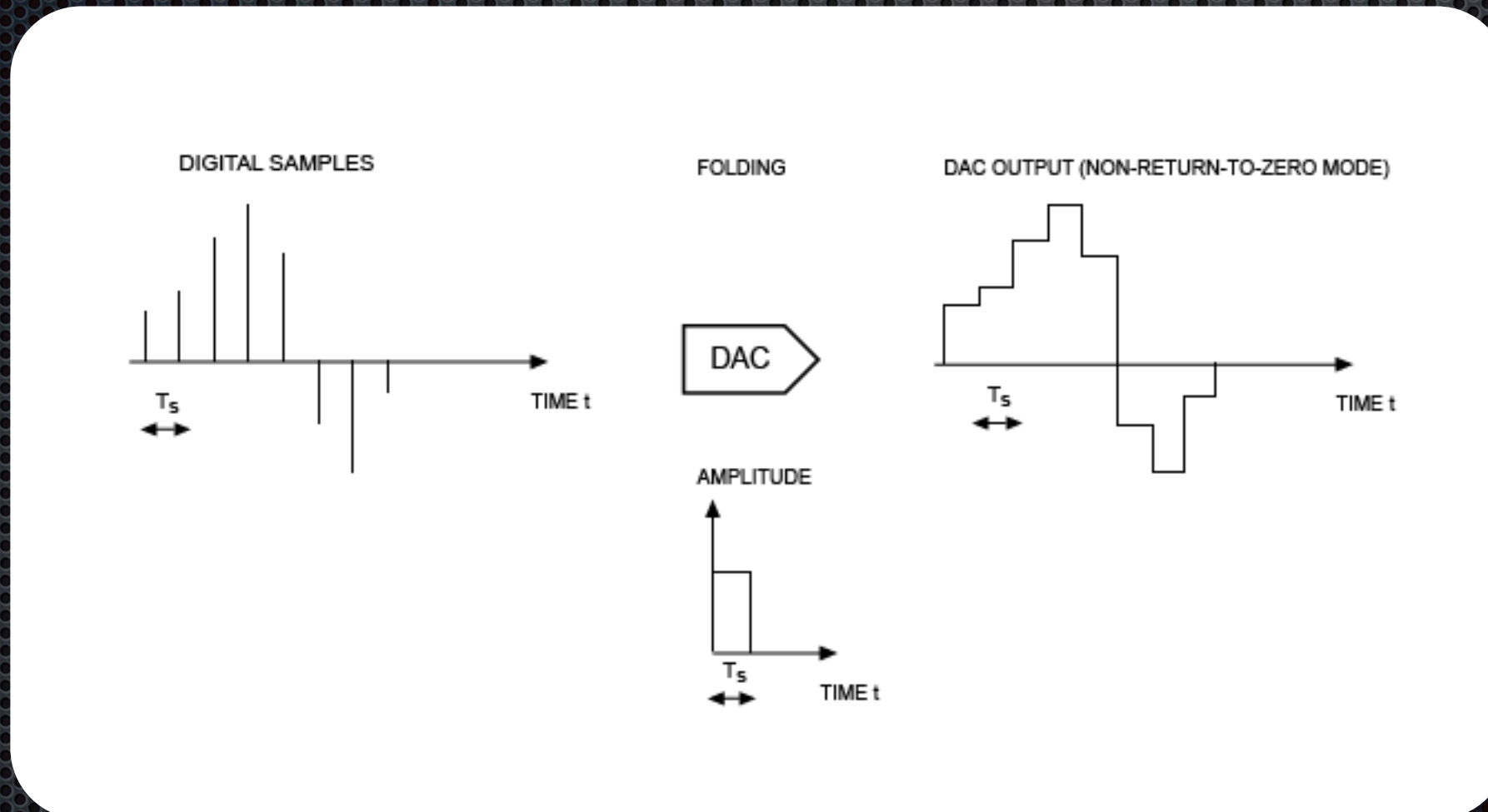

DAC

